

Chrysler Multi-kit 1998-2010

INTRODUCTION

This instruction booklet will cover (3) different kits, yet carry the same applications and dash disassembly. After dash disassembly is complete, refer to the appropriate page for the kit being used.

APPLICATIONS

CHRYSLER	CHRYSLER	DODGE	DODGE (CONT)	JEEP
300M	1999-2004	Sebring	2001-2006	Caravan/ Neon
Concorde	1998-2004	Town & Country	2001-2007	Grand Caravan
LHS	1999-2001	Voyager	2001-2003	Dakota
PT Cruiser	2001-2005			Durango
				Intrepid
				Stratus
				Viper
				2003-2010
				PLYMOUTH
				Neon
				2000-2001
				Grand Cherokee
				Liberty
				Wrangler

TABLE OF CONTENTS

Dash Disassembly	2
Kit Assembly	
- 99-6503	10-11
- 99-6504	12-13
- 99-6505	14-15

WIRING & ANTENNA CONNECTIONS (sold separately)

Wiring Harness: Please visit metraonline.com for harness options

Antenna Adapter: Please visit metraonline.com for antenna adapter options

TOOLS REQUIRED

- Phillips Screwdriver • T-20 Torx screwdriver
- Panel removal tool

CAUTION! All accessories, switches, climate controls panels, and especially air bag indicator lights must be connected before cycling the ignition. Also, do not remove the factory radio with the key in the on position, or while the vehicle is running.

DASH DISASSEMBLY TABLE OF CONTENTS

CHRYSLER

- 300M 1999-2004/Concorde 1998-2004.....	3
- LHS 1999-2001.....	3
- PT Cruiser 2001-2005.....	3
- Sebring 2001-2006.....	4
- Town & Country 2001-2007.....	4
- Voyager 2001-2003.....	4

DODGE

- Caravan/Grand Caravan 2001-2007.....	4
- Dakota 2001-2004/Durango 2001-2003.....	6
- Intrepid 1998-2004.....	3
- Neon 2000-2006.....	5
- Ram 2002-2005.....	5
- Stratus 2001-2006.....	4
- Viper 2003-2010.....	8

JEEP

- Grand Cherokee 1999-2004.....	6
- Liberty 2002-2007.....	7
- Wrangler 2003-2006.....	7

PLYMOUTH

- Neon 2000-2001.....	5
-----------------------	---

DASH DISASSEMBLY

Chrysler 300M 1999-2004 / Concorde 1998-2004 / LHS 1999-2001 Dodge Intrepid 1998-2004

1. Remove the ashtray by pressing down on the inner spring clip. (Concorde only)
2. Unclip the gear shifter trim panel and slide the trim panel toward the rear of the vehicle.
3. Unclip the dash trim panel and disconnect the wire to the trim panel.
4. Remove (4) Phillips screws securing the radio. Disconnect and remove the radio.

Continue to Kit Assembly

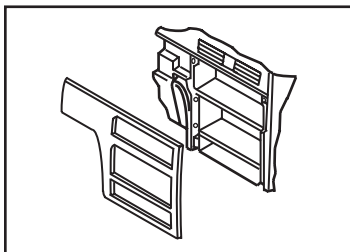

Chrysler PT Cruiser 2001-2005

1. Unclip the power window control panel. Disconnect and remove the panel.
2. Pull off the climate control knobs.
3. Unclip and remove the dash trim panel.
4. Remove (4) Phillips screws securing the radio. Disconnect and remove the radio.

Continue to Kit Assembly

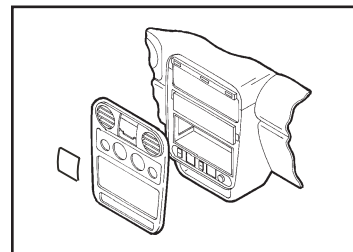

DASH DISASSEMBLY

Chrysler Sebring 2001-2006 Dodge Stratus 2001-2006

1. Remove (2) Phillips screws from under the climate controls. (Coupe only)
2. Unclip and remove the radio trim panel.
3. Remove (4) Phillips screws securing the radio. Disconnect and remove the radio.

Continue to Kit Assembly

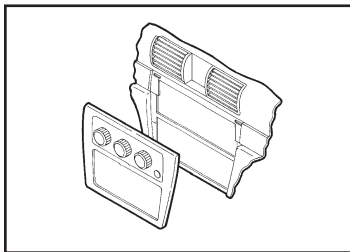

Chrysler Town & Country 2001-2007 / Voyager 2001-2003 Dodge Caravan / Grand Caravan 2001-2007

1. Open the cup holder. Unclip and remove the trim above the cup holder.
2. Remove (2) Phillips screws from above the cup holder.
3. Unclip and remove the dash trim panel.
4. Remove (4) Phillips screws securing the radio. Disconnect and remove the radio.

Continue to Kit Assembly

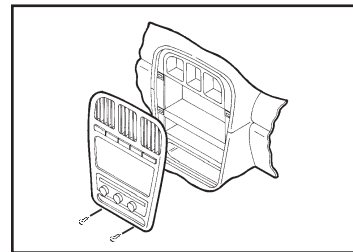

DASH DISASSEMBLY

Dodge Neon 2000-2006 Plymouth Neon 2000-2001

1. Pull off the climate control knobs.
2. Unclip and remove the ac / heater vents.
3. Remove (1) Phillips screw from each vent cavity.
4. Unclip and remove the dash trim panel.
5. Remove (4) Phillips screws securing the radio. Disconnect and remove the radio.

Continue to Kit Assembly

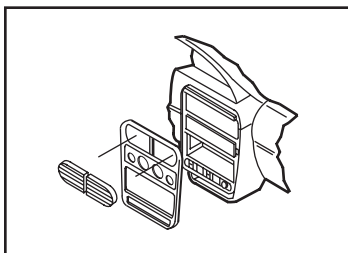

Dodge Ram 2002-2005

1. Unclip the top edge of the trim panel below the steering column. (It is not necessary to completely remove this panel).
2. Remove (1) Phillips screw from below the right ac/heater vent.
3. Unclip and remove the dash trim panel.
4. Remove (4) Phillips screws securing the radio. Disconnect and remove the radio.

Continue to Kit Assembly

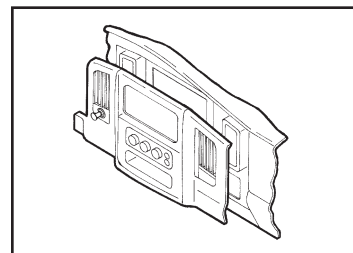

DASH DISASSEMBLY

Jeep Grand Cherokee 1999-2004

1. Unclip and remove the radio trim panel.
2. Remove (4) Phillips screws securing the radio. Disconnect and remove the radio.

Continue to Kit Assembly

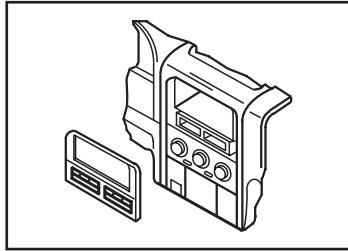

Dodge Dakota 2001-2004 / Durango 2001-2003

1. Remove (3) T-20 Torx screws from the bottom edge of the panel below the steering column and unsnap to remove the panel.
2. Remove (2) Phillips screws from the instrument cluster panel above the gauges.
3. Remove (3) T-20 Torx screws from the bottom of the steering column shroud. Unsnap and remove the top half of the shroud.
4. Unsnap and remove the entire panel surrounding the radio, a/c controls, and instrument cluster.
5. Remove (4) Phillips screws securing the radio. Disconnect and remove the radio.

Continue to Kit Assembly

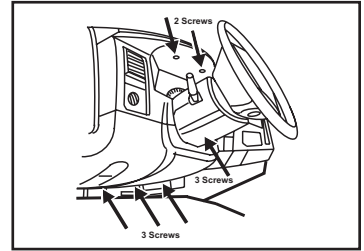

DASH DISASSEMBLY

Jeep Liberty 2002-2007

1. Remove the ashtray and remove (1) Phillips screw exposed.
2. Unclip and remove the radio / climate control panel.
3. Remove (4) Phillips screws securing the radio. Disconnect and remove the radio.

Continue to Kit Assembly

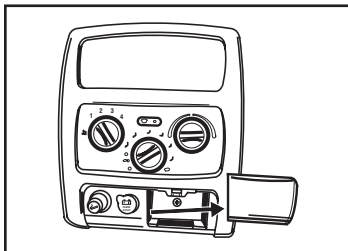

Jeep Wrangler 2003-2006

1. Unsnap and remove the defroster grille panel near the windshield.
2. Remove (2) Phillips screws exposed at the top of the center of the dash panel. Unsnap and remove the panel.
3. Remove the glove box door to access (1) 10mm nut on the back of the radio.
4. Remove (4) Phillips screws securing the radio. Disconnect and remove the radio.

Continue to Kit Assembly

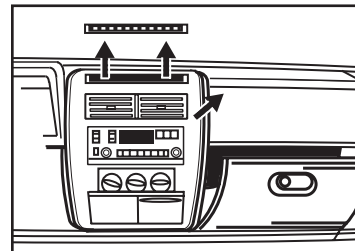

DASH DISASSEMBLY

Dodge Viper 2003-2010

1. Using a panel removal tool, pry up on the center console trim panel. Be careful not to scratch the trim panel. (Figure A)
2. Loosen the shifter lock nut below the center console trim panel (Figure A), and unscrew the shifter knob. (Figure B)
3. Unplug the electrical connectors and remove the center console trim panel. (Figure C)
4. Remove (6) Allen screws from the radio / climate control trim panel, and (1) Phillips screw at the bottom of the panel.
5. Unplug the electrical connectors and remove the panel. (Figure D)
6. Remove (4) screws securing the radio. Disconnect and remove the radio.

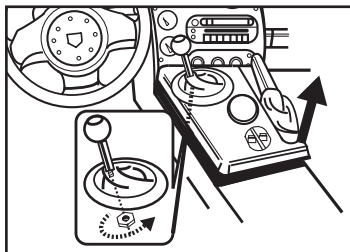

(Figure A)

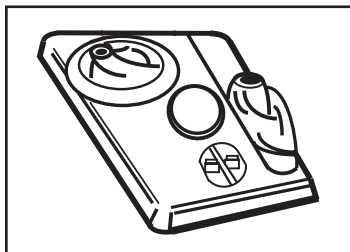

(Figure C)

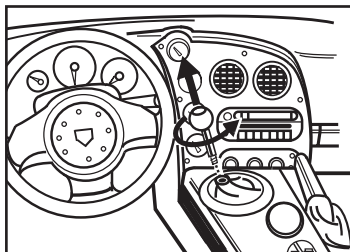

(Figure B)

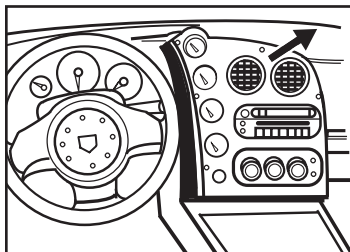

(Figure D)

Continue to Kit Assembly

Chrysler **Multi-kit** 1998-2010

KIT FEATURES

- DIN radio provision

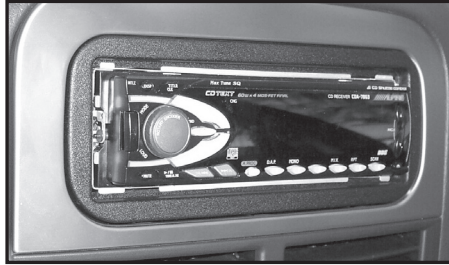

KIT COMPONENTS

- A) Radio housing

A

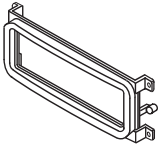

WIRING & ANTENNA CONNECTIONS (sold separately)

Wiring Harness: • Please visit metraonline.com for wiring harness options

Antenna Adapter: • Please visit metraonline.com for antenna adapter options

TOOLS REQUIRED

- Phillips Screwdriver • T-20 Torx screwdriver • Panel removal tool

KIT ASSEMBLY

DIN radio provision

1. Remove the metal DIN sleeve from the aftermarket radio.
2. Slide the sleeve into the *radio housing* and secure by bending the metal locking tabs down.
3. Slide the radio into the sleeve until it clicks in. (Figure A)
4. Locate the factory wiring harness in the dash. Metra recommends using the proper mating adapter from Metra or AXXESS. Test the radio for proper operation.
5. Reassemble the dash in reverse order of disassembly. (Figure A)

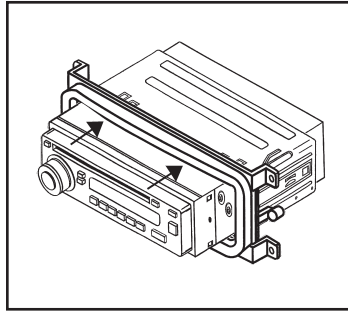

(Figure A)

Chrysler **Multi-kit** 1998-2010

KIT FEATURES

- ISO DIN radio provision with pocket



KIT COMPONENTS

- A) Radio housing • B) ISO brackets

A

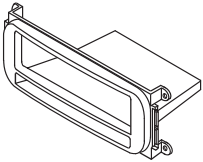

B

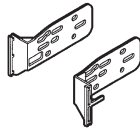

WIRING & ANTENNA CONNECTIONS (sold separately)

Wiring Harness: • Please visit metraonline.com for wiring harness options

Antenna Adapter: • Please visit metraonline.com for antenna adapter options

TOOLS REQUIRED

- Phillips Screwdriver • T-20 Torx screwdriver • Panel removal tool

KIT ASSEMBLY

ISO DIN radio provision with pocket

1. Attach the *ISO brackets* to the *radio housing* by sliding the bracket tabs into the housing slots. (Figure A)
2. Remove the metal DIN sleeve and trim ring from the aftermarket radio.
3. Slide the radio into the *radio housing*.
4. Align the holes in the radio with the holes in the *ISO brackets* and mount the radio to 3 with the screws supplied with the radio. (Figure B)
5. Locate the factory wiring harness and antenna connector in the dash and complete all necessary connections to the radio. Metra recommends using the proper mating adapter from Metra and/or AXCESS. Test the radio for proper operation.
6. Reassemble the dash in reverse order of disassembly.

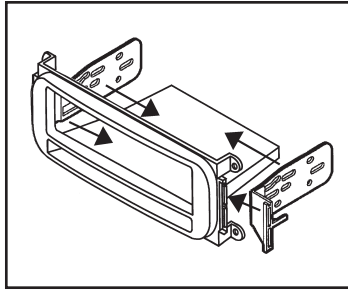

(Figure A)

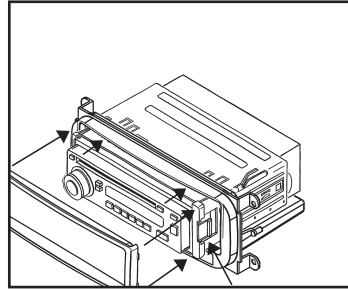

(Figure B)

Chrysler **Multi-kit** 1998-2010

KIT FEATURES

- DIN radio provision with pocket
- ISO DIN radio provision with pocket



KIT COMPONENTS

- A) Radio housing • B) ISO trim plate • C) ISO snap-in brackets

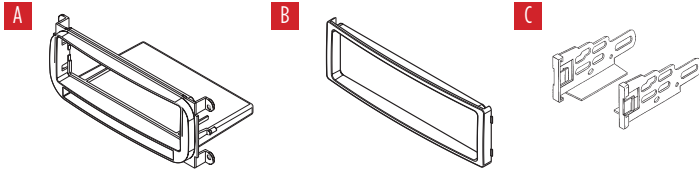

WIRING & ANTENNA CONNECTIONS (sold separately)

Wiring Harness: • Please visit metraonline.com for wiring harness options

Antenna Adapter: • Please visit metraonline.com for antenna adapter options

TOOLS REQUIRED

- Phillips Screwdriver • T-20 Torx screwdriver • Panel removal tool

KIT ASSEMBLY

DIN radio provision with pocket

1. Remove the metal DIN sleeve from the aftermarket radio.
2. Slide the sleeve into the assembly and secure by bending the metal locking tabs down. (Figure A)
3. Slide the radio into the sleeve until secure. (Figure B)
4. Locate the factory wiring harness and antenna connector in the dash and make all necessary connections to the radio. Metra recommends using the proper mating adapters from Metra and/or AXCESS. Reconnect the negative battery terminal and test the radio for proper operation.
5. Reassemble the dash in reverse order of disassembly.

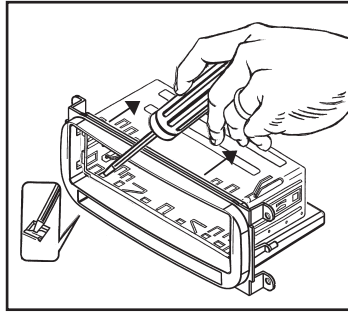

(Figure A)

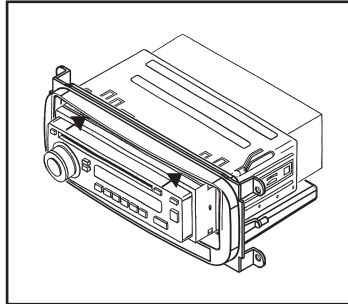

(Figure B)

ISO DIN radio provision with pocket

1. Remove the metal DIN sleeve and trim ring from the aftermarket radio.
2. Align the holes in the ISO snap-in brackets with the holes in the radio and mount the brackets to the radio with the screws supplied with the radio. (Figure A)
3. Slide the radio/bracket assembly into the radio opening until the side clips engage. (Figure B)
4. Locate the factory wiring harness and antenna connector in the dash and make all necessary connections to the radio. Metra recommends using the proper mating adapters from Metra and/or AXCESS. Reconnect the negative battery terminal and test the radio for proper operation.
5. Reassemble the dash in reverse order of disassembly.

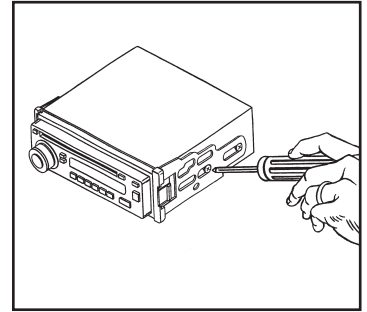

(Figure A)

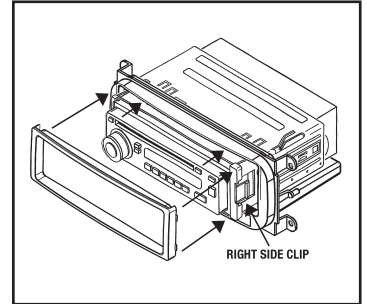

(Figure B)



99-650345
INSTALLATION INSTRUCTIONS



IMPORTANT

If you are having difficulties with the installation of this product, please call our Tech Support line at 1-800-253-TECH. Before doing so, look over the instructions a second time, and make sure the installation was performed exactly as the instructions are stated. Please have the vehicle apart and ready to perform troubleshooting steps before calling.



KNOWLEDGE IS POWER

Enhance your installation and fabrication skills by enrolling in the most recognized and respected mobile electronics school in our industry. Log onto www.installerinstitute.com or call 800-354-6782 for more information and take steps toward a better tomorrow.



**Metra recommends MECP
certified technicians**