



INSTALLATION INSTRUCTIONS FOR PART 95-7622HG

APPLICATIONS

Nissan Rogue 2014-up 95-7622HG



KIT FEATURES

- Double DIN radio provision
- **Painted High Gloss Black Metallic**

KIT COMPONENTS

- A) Radio housing • B) Brackets

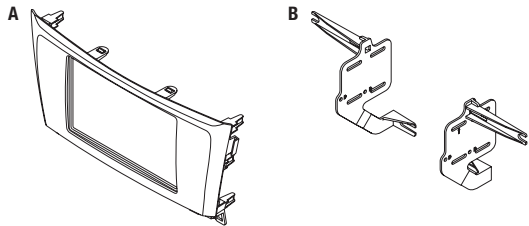

WIRING & ANTENNA CONNECTIONS (sold separately)

Wiring Harness: • 70-7552 Nissan Harness

Antenna Adapter: • 40-NI12 Nissan Antenna Adapter

Table of Contents

Dash Disassembly

– Nissan Rogue 2014-up 2

Kit Assembly

– Double DIN radio provision 3

TOOLS REQUIRED

- Panel removal tool • Phillips screwdriver

CAUTION: Metra recommends disconnecting the negative battery terminal before beginning any installation. All accessories, switches, and especially air bag indicator lights must be plugged in before reconnecting the battery or cycling the ignition.

NOTE: Refer to the instructions included with the aftermarket radio.

Dash Disassembly

1. Unclip and remove the trim panel on the end of the passenger side of the dash. (Figure A)
2. Remove (1) Phillips screw securing the A/C vent then unclip and remove the vent. (Figure B)
3. Unclip and remove the trim panel above the glove box starting at the vent and working your way over to the radio. **Note: There is a hook on the radio side of this panel so make sure you start from the vent on the passenger side.** (Figure C)

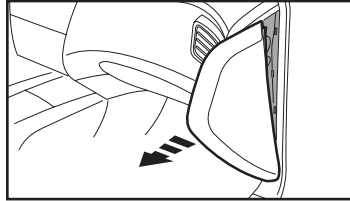

(Figure A)

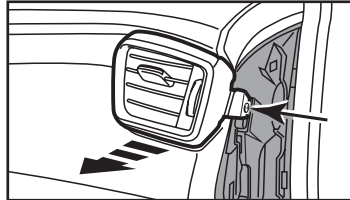

(Figure B)

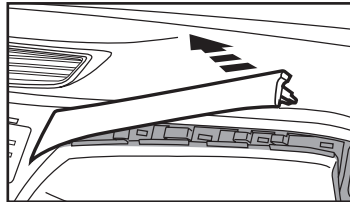

(Figure C)

4. Unclip and remove the A/C control. (Figure D)
5. Unclip and remove the trim panel to the left of the factory radio. **Note: On push to start models this panel will have the start button on it.** (Figure E)
6. Remove (4) Phillips screws securing the factory radio then unclip and remove the radio. (Figure F)

Continue to kit assembly

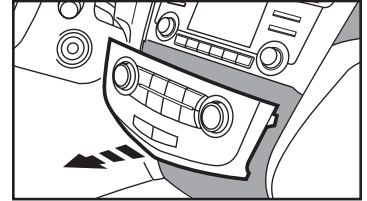

(Figure D)

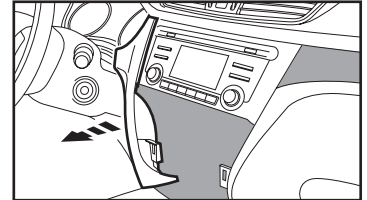

(Figure E)

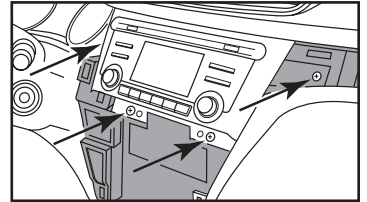

(Figure F)

Kit Assembly

Double DIN radio provision

1. Locate the factory wiring harness in the dash. Metra recommends using the proper mating adapter from Metra or AXXESS. Re-connect the negative battery terminal and test the unit for proper operation.
2. Attach the radio to the brackets with the screws supplied with the radio and mount into the dash opening. (Figure A)
3. Snap the radio housing over the radio/bracket assembly.
4. Reassemble dash in reverse order of disassembly.

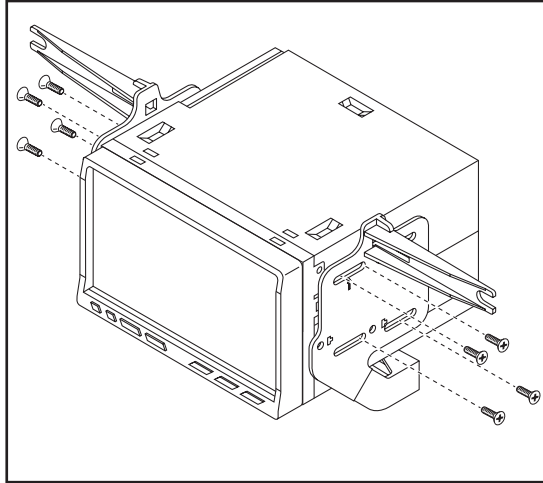

(Figure A)



INSTALLATION INSTRUCTIONS FOR PART 95-7622HG



REV. 9/12/2014 INST95-7622HG



KNOWLEDGE IS POWER

Enhance your installation and fabrication skills by enrolling in the most recognized and respected mobile electronics school in our industry. Log onto www.installerinstitute.com or call 800-354-6782 for more information and take steps toward a better tomorrow.



Metra recommends MECP certified technicians



INSTRUCCIONES DE INSTALACIÓN PARA LA PIEZA 95-7622HG

APLICACIONES

Nissan Rogue 2014 y mas 95-7622HG

CARACTERÍSTICAS DEL KIT

- Provisiones de radio ISO DDIN.
- *Pintura negra metálica de alto brillo*

COMPONENTES DEL KIT

- A) Carcasa del radio • B) Soportes

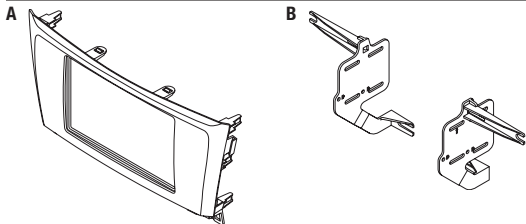

CABLEADO Y CONEXIONES DE ANTENA (se venden por separado)

Arnés de cables: • Arnés Nissan 70-7552

Adaptador de antena: • Adaptador de antena Nissan 40-NI12

Indice

Desmontaje del tablero

– Nissan Rogue 2014 y mas..... 2

Ensamble del kit

– Provisión de radio ISO DDIN 3

HERRAMIENTAS REQUERIDAS

- Herramienta para quitar paneles
- Destornillador Phillips

PRECAUCIÓN: *Metra recomienda desconectar el terminal negativo de la batería antes de comenzar cualquier instalación. Todos los accesorios, interruptores y, especialmente, las luces indicadoras de airbag deben estar enchufados antes de volver a conectar la batería o comenzar el ciclo de ignición.*

Nota: *Remítase a las instrucciones incluidas con el radio de posventa.*

REV.9/12/2014 INST95-7622HG

Desmontaje del tablero

1. Desenganche y quite el panel de moldura que está al final del lado del pasajero en el tablero. (Figura A)
2. Quite (1) tornillo Phillips que sujeta la rejilla del aire acondicionado, luego desenganche y quite la rejilla. (Figura B)
3. Desenganche y retire el panel de la moldura de arriba de la guantera, empezando en la rejilla y avanzando hacia el radio. **Nota: Hay un gancho en el lado del radio de este panel, así que asegúrese de empezar desde la rejilla del lado del pasajero.** (Figura C)

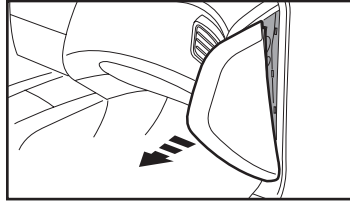

(Figura A)

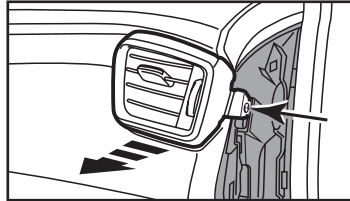

(Figura B)

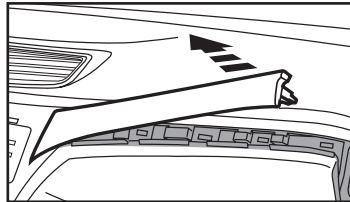

(Figura C)

4. Desenganche y quite el control del aire acondicionado. (Figura D)
5. Desenganche y quite el panel de moldura a la izquierda del radio de fábrica. **Nota: En los modelos de presionar para arrancar, este panel contendrá el botón de inicio.** (Figura E)
6. Quite los (4) tornillos Phillips que sujetan el radio de fábrica, luego desenganche y quite el radio. (Figura F)

Continúe con el ensamble del kit

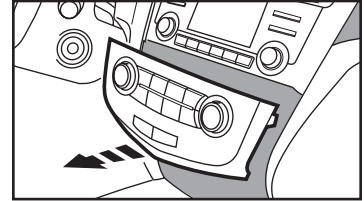

(Figura D)

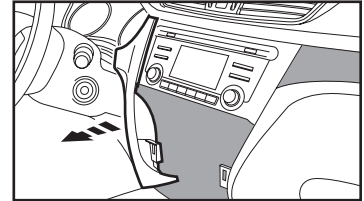

(Figura E)

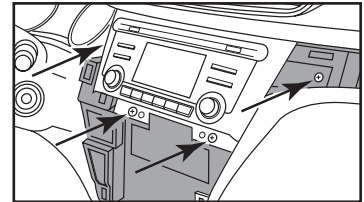

(Figura F)

Ensamble del kit

Provisión de radio ISO DDIN

1. Coloque el radio en los soportes con los tornillos que vienen con el radio y monte en la apertura del tablero. (Figura A)
2. Ubique el arnés de cableado de fábrica en el tablero. Metra recomienda el uso de un adaptador adecuado de acoplamiento de Metra o de AXXESS. Vuelva a conectar la terminal negativa de la batería y pruebe la unidad para verificar que funcione correctamente.
3. Coloque a presión la carcasa del radio sobre el nuevo ensamble de radio/soporte.
4. Vuelva a armar el tablero al revés de como lo desarmó.

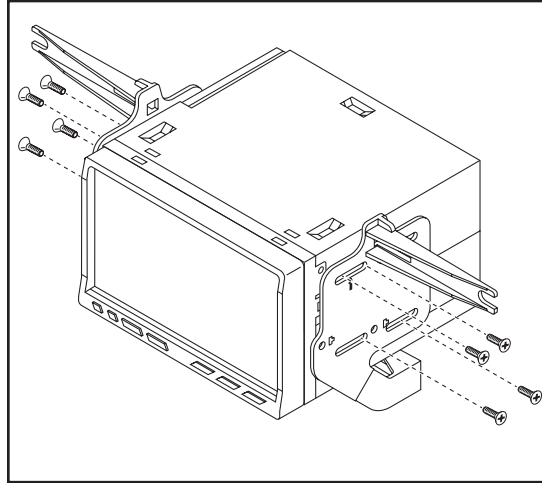

(Figura A)



INSTRUCCIONES DE INSTALACIÓN PARA LA PIEZA 95-7622HG



REV.9/12/2014 INST95-7622HG



EL CONOCIMIENTO ES PODER

Mejora sus habilidades de instalación y fabricación inscribiéndose en la escuela de dispositivos electrónicos móviles más reconocida y respetada de nuestra industria. Regístrese en www.installerinstitute.com o llame al 800-354-6782 para obtener más información y avance hacia un futuro mejor.



Metra recomienda técnicos con certificación del Programa de Certificación en Electrónica Móvil (Mobile Electronics Certification Program, MECP).