



Porsche Macan (95B) 2015-2016

Non-Amplified vehicles, with OEM parking sensors and graphics on vehicle screen

Visit MetraOnline.com for more detailed information about the product and up-to-date vehicle specific applications

KIT FEATURES

- ISO DDIN radio provision
- Includes an Axxess interface for retaining CAN data information
- Includes an Axxess interface for retaining steering wheel control functionality
- Painted matte black

KIT COMPONENTS

- A) Radio trim panel • B) Radio brackets • C) (4) #8 3/8" Phillips screws

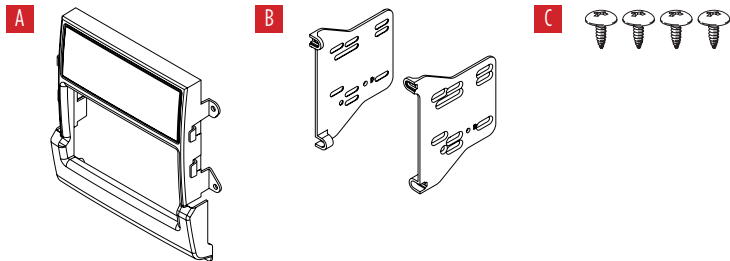

TABLE OF CONTENTS

Dash Disassembly	2
Kit Assembly	3
Axxess Interface Installation.....	4-10
Final Assembly.....	7

WIRING & ANTENNA CONNECTIONS

Wiring Harness: Included with kit
 Antenna Adapter: Included with kit
 Steering Wheel Control Interface:
 Included with kit

TOOLS REQUIRED

- 3mm Allen screwdriver • Long hook tool
- Panel removal tool • T-27 Torx screwdriver

Attention! Let the vehicle sit with the key out of the ignition for a few minutes before removing the factory radio. When testing the aftermarket equipment, ensure that all factory equipment is connected before cycling the key to ignition.

DASH DISASSEMBLY

1. Unclip and remove the a/c vent panel to the left of the radio. (Figure A)

Tip! A long-hook too can be inserted into the vent to grab it from the back.

2. Unclip and remove the passenger-side dashboard trim panel. (Figure B)
3. Remove (4) T-27 Torx screws securing the radio. (Figure C)

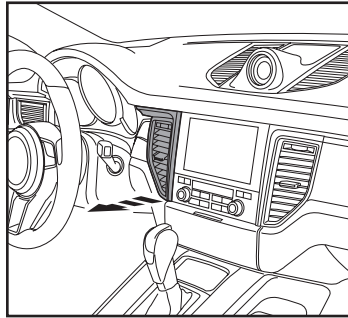

(Figure A)

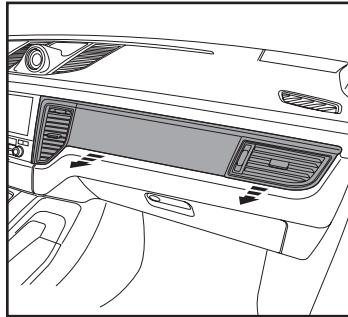

(Figure B)

4. Carefully remove the hinged door covering the DVD drive. (Figure D)
5. With the parking brake on, put the gear shifter in reverse to allow the radio to be removed in the following step.
6. Unclip and slide the radio assembly out, then unplug and remove.

Continue to Kit Assembly

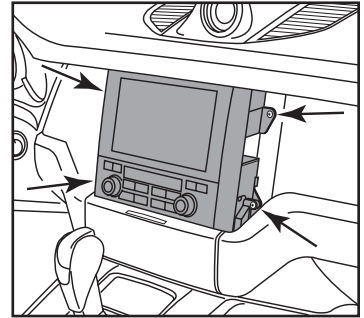

(Figure C)

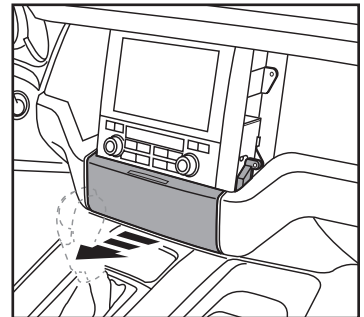

(Figure D)

KIT ASSEMBLY

1. Attach the **radio brackets** to the **radio trim panel** using (4) #8 x 3/8" Phillips screws supplied. (Figure A)
2. Slide the radio into the completed assembly, and then secure it to the assembly using screws supplied with the radio.

*Continue to Axxess
Interface Installation*

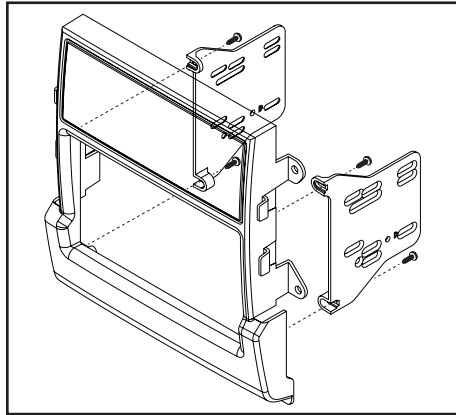

(Figure A)

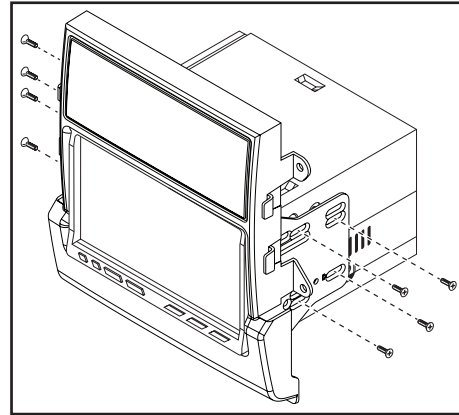

(Figure B)

AXXESS INTERFACE INSTALLATION

INTERFACE FEATURES

- Provides accessory power
- Provides illumination, parking brake, reverse, and speed sense outputs
- Retains audio controls on the steering wheel
- Retains parking sensor audio
- Retains parking sensor graphics †
- Retains the factory backup camera
- Retains the factory AUX-IN jack and USB port
- Retains balance
- Micro-B USB updatable

† Through the backup camera input from the aftermarket radio

INTERFACE COMPONENTS

- 9615 interface
- SWC interface
- 9615 harness (labeled LEAD 1458)
- SWC harness (labeled LEAD 1214)
- USB harness
- 3.5mm adapter
- Antenna adapter

TABLE OF CONTENTS

Connections.....	5
Installation	6
Programming.....	6
User guide.....	8-10

TOOLS REQUIRED

- Crimping tool and connectors, or solder gun, solder, and heat shrink
- Tape
- Wire cutter
- Zip ties

CONNECTIONS

From the 9615 harness to the aftermarket radio, connect the:

- **Black** wire to the ground wire.
- **Yellow** wire to the battery wire
- **Red** wire to the accessory wire.
Note: There will also be a **Red** wire on the SWC harness to connect as well.
- **Blue** wire to the power antenna wire.
- **Blue/White** wire to the amp turn on wire.
- **Orange** wire to the illumination wire. †
- **Brown** wire to the mute wire. †
- **Blue/Pink** wire to the speed sense wire.
- **Green/Purple** wire to the reverse wire. †
- **Light Green** wire to the parking brake wire. †
- **Yellow** RCA jack to the Yellow RCA jack from the SWC Harness labeled “To Reverse Camera”. ‡
- **Red & White** RCA jacks labeled “FRONT LEFT” and “FRONT RIGHT” to the full range front amplifier output jacks.
- **Red & White** RCA jacks labeled “AUX Left” and “AUX Right” to the audio AUX-IN jacks. †
- Disregard the following (8) wires:
Gray, Gray/Black, Green, Green/Black, Purple, Purple/Black, White, White/Black

† If applicable

‡ Mandatory connection to retain parking sensor graphics

From the SWC harness to the aftermarket radio:

- Parrot: Connect the AX-SWC-PARROT (sold separately) to the 3.5mm jack, then to the radio.
- **For the radios listed below:** Connect the 3.5mm adapter to the 3.5mm jack.
 - **Eclipse:** Brown - Brown/White/Brown/White - Brown
 - **Kenwood/JVC (with SWC wire):** Blue/Yellow - Brown
 - **Metra OE:** Key 1 (Gray) - Brown
 - **Universal “2 or 3 wire” radio:** Key-A or SWC-1 - Brown/Key-B or SWC-2 - Brown/White
Note: After programming, assign SWC buttons within menu.
 - **XITE:** SWC-2 - Brown
- **For all other radios:** Connect the 3.5mm jack to the radio.
- Connect the **Red** wire to accessory power.
- Connect the **Yellow** RCA jack labeled “To Reverse Camera Input (Radio)”, to the backup camera input. ‡

‡ Mandatory connection to retain parking sensor graphics

INSTALLATION

With the ignition switch in the off position, connect the:

1. **SWC harness** to the **SWC interface**, then to the **9615 interface**.
2. **9615 harness** to the **9615 interface**, then to the wiring harness in the vehicle.
3. **USB harness** to the radio, then to the wiring harness in the vehicle.
4. Locate the factory antenna connector in the dash and complete all necessary connections to the radio. Use the **antenna adapter** provided to adapt the factory antenna to the aftermarket radio.

PROGRAMMING

1. Open the driver's door and keep open during the programming process.
2. Press and hold the **Volume Up** button on the steering wheel. For models with a scroll wheel, scroll up quickly.
3. Cycle the ignition switch on.
4. The LED in the **SWC interface** will quickly flash **Green** and **Red**. **(a)**
5. The LED will go out, then flash **Green** while the interface programs itself to the vehicle. **(b)**
6. The LED will go out again, then flash **Red** up to 22 times while the interface programs itself to the radio. **(c)**
7. Once programmed, the LED will go out briefly, then turn solid **Red**. **(d)**
8. Release from holding the **Volume Up** button. Test all functions of the installation for proper operation. **(e)**
 - (a)** If the LED doesn't flash, press the reset button for 3 seconds to reset the interface.
 - (b)** There will be a series of 7 **Green** flashes, some short, some long. The long flashes represent the wires connected to the interface. The 3rd, 4th, 5th, and 6th flashes should be longer.
 - (c)** The number of flashes identify the radio installed. Refer to the **AXSWC Radio Troubleshooting** document available from axessinterfaces.com for more information.
 - (d)** If the LED didn't turn solid **Red**, press the reset button for 3 seconds to start the process over again, then resume from step 3.
 - (e)** Refer to the AXSWC documents available from axessinterfaces.com for customizing the SWC buttons.

Continue to Final Assembly

FINAL ASSEMBLY

1. Secure the radio assembly into the dash using the factory hardware and reassemble the dash in reverse order of disassembly.

Steering Wheel Control Functionality

In Normal Mode

1. Volume Up (Scroll Up)
Volume Down (Scroll Down)
Mute (Short Press)
Enter Infodapter Menu (Long Press)
2. *Programmable Function (Short Press)
Programmable Function (Long Press)
3. Pick Up
4. Instrument Cluster Nav
5. Instrument Cluster Nav
6. Hang Up
7. Source (Short Press)
Voice Assist (Long Press)

In Infodapter Mode

1. Menu Up (Scroll Up)
Menu Down (Scroll Down)
Select Menu Item (Short Press)
Exit Infodapter Menu (Long Press)
Buttons 2-7 function as above

In Parking Mode (when camera is active)

1. Camera/Parking Graphics Toggle (Long Press)

*Programmable button



The diamond button on the steering wheel can be programmed to perform a specific radio function within the Infodapter menus on both a long and short press.

Function options include Source, Track +, Track -, DSC + and DSC -

To assign a function to the button, enter the Infodapter menu and go into the 'Preferences' sub-menu. From here, select the desired button function against the 'Diamond Short Press' and 'Diamond Long Press' options.

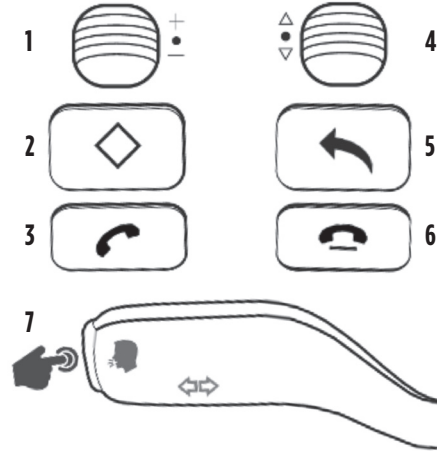

NOTE: If you wish to use the diamond button as described above, ensure that the button is set to any radio function in the vehicle's OEM instrument cluster menu. If you do not wish to use the button for this purpose, ensure that both short and long press options are set to 'None' in the Infodapter Preferences sub menu.

Continued on the next page

Infodapter Menu

Press and hold Button 1 to enter the Infodapter menu and navigate through the various options and settings:

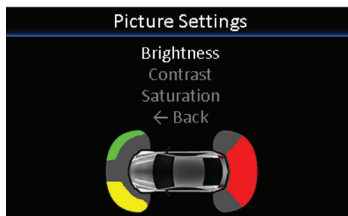
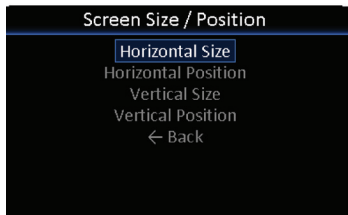
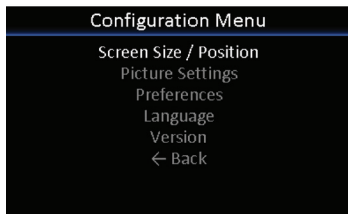

Preferences

-> **Camera Connected (None/Generic/OEM)**

Choose the style of camera connected to the vehicle (if applicable)

-> ***Camera Active (OEM/Reverse)**

Choose if the camera image appears on the display at times triggered by the Porsche system, or only when reverse gear is active

-> ***RVC Grid Lines (Yes/No)**

Rear view camera guidelines on/off

-> ****Reverse Priority (Park Assist/Camera)**

Choose if the display shows the parking graphics or reversing camera image on screen. Note – this can also be changed instantly via the steering wheel controls for faster switching. See “In Parking Mode (when camera is active) for more information.

-> ****Camera Delay (0 -> 20)**

Increase camera delay to prevent ‘rolling’ effect on screen when switching between video inputs

-> **Diamond Short Press (None/SRC/TRK+/TRK-/DSK+/DSK-)**

Select short press function for the Diamond button on the steering wheel controls

-> **Diamond Long Press (None/SRC/TRK+/TRK-/DSK+/DSK-)**

Select long press function for the Diamond button on the steering wheel controls

-> **Park Brake Source (PRNDM/Speed/Brake/Always On)**

Set Park Brake output to activate when park brake is on (Brake), when speed is less than 2mph (Speed), when gear shifter is set to ‘Park’ (PRNDM) or to remain on at all times (Always On)

-> **Restore Factory Settings (Yes/No)**

Select Yes to return all Infodapter settings to factory defaults

Language

-> Select language (English/French/German/etc)

Version

-> View software version screen

Continued on the next page

OEM Parking sensor graphics

The Infodapter interface will automatically generate a replication of the OEM front/rear parking sensor graphics based on the vehicle's data. These graphics have been designed to exactly replicate Porsche's original as closely as possible to retain the OEM feel of the system.

Switching between camera and graphic display modes

To toggle between the reversing camera and the parking graphics when one of them is active on screen, hold down Button 1 while the camera or graphics are active. This setting can also be changed by the 'Reverse Priority' setting in the preferences sub-menu.

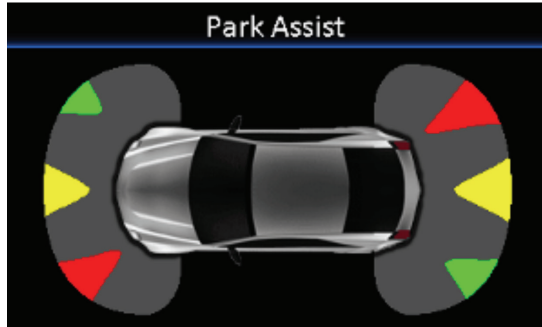
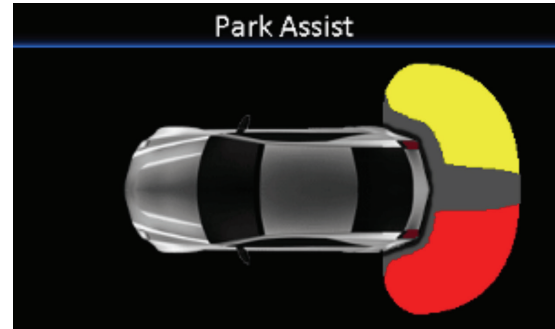
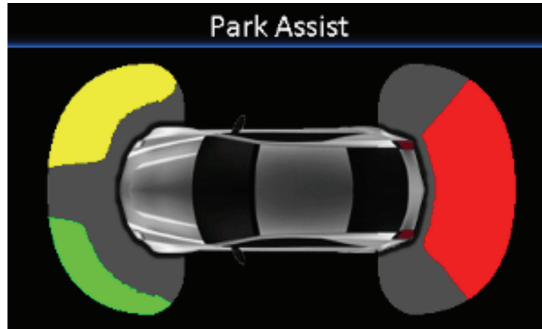





95-9615B
INSTALLATION INSTRUCTIONS



Having difficulties? We're here to help.



Contact our Tech Support line at:

386-257-1187



Or via email at:

techsupport@metra-autosound.com

Tech Support Hours (Eastern Standard Time)

Monday - Friday: 9:00 AM - 7:00 PM

Saturday: 10:00 AM - 7:00 PM

Sunday: 10:00 AM - 4:00 PM



KNOWLEDGE IS POWER

Enhance your installation and fabrication skills by enrolling in the most recognized and respected mobile electronics school in our industry. Log onto www.installerinstitute.com or call 800-354-6782 for more information and take steps toward a better tomorrow.



**Metra recommends MECP
certified technicians**