



**RGB LED Wireless App Controlled**

**Replacement Headlights**

**MPS-RZ1RGB**

**MPS-RZ1LEDH**

**(Polaris Extreme LED Headlights with Lighted Halo)**

**Introduction:**

Metra PowerSports Introduces New Extreme LED Headlight for Polaris Razor and General. These new lights have a powerful set of Cree Led to make your trail riding clear and safer. They have an illuminated Halo ring to help enhance you presence on the trails Day or night. The LEDH version offers a Super Bright WHITE halo Ring. The RGB version offers the ability to control the Halo ring on the Headlight with your Wireless enabled Smart phone or other device. The RGB Headlight allows you to create millions of different color combinations as well as flashing light combinations.



**Important**

Thank you for purchasing MetraPowerSports® products for your Polaris®

Installation is fairly simple with the right tools and good mechanical abilities.

If you are not confident in your mechanical skills, please seek the help of a professional to perform the installation.

Please read through all of these instructions and tips before proceeding with the installation.

**It is strongly recommended that this product be installed by a professional.**

**Parts Included:**

- (2) RGB Headlight Assemblies (Driver + Passenger Side)
- (2) H4 (9003) to 3 wire (H13) RGB light Pigtail Connector Assembly
- (2) H4 (9003) to 4 wire (Delphi) RGB light Pigtail Connector Assembly
- (1) 1 RGB Controller harness adaptor

**Tools Needed:**

T25 Torx driver

1. Remove original headlights (3 screws each) with a T25 Torx driver. Fig A

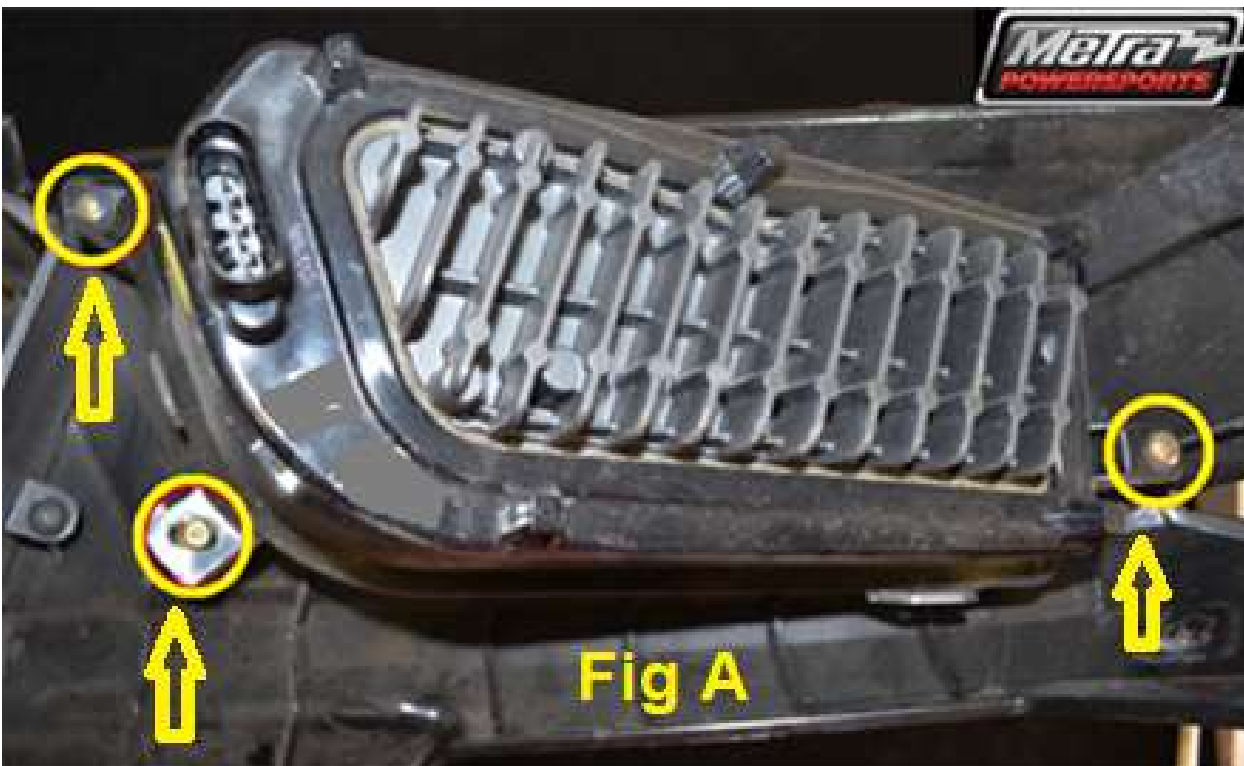



The stock screws and springs will be used for the new MPS-RZ# headlight installation. Fig B



Note: Installation may be easier by removing the front fascia / grill but is not necessary.

2. Install the (2) new MPS-RZxxx headlights by using the stock hardware.

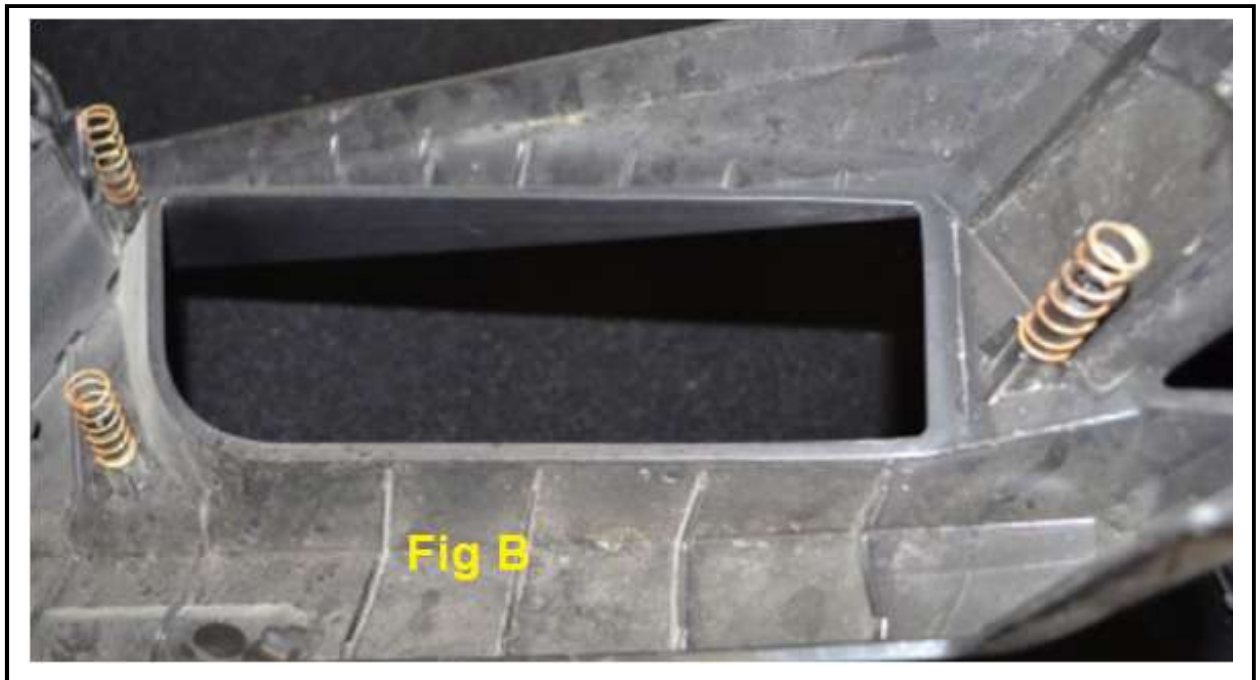

3. Chose the correct connector adaptor



Vehicles equipped with 4 Pin plug OEM Composite LED lights refer to Diagram #1

**Diagram #1**

Polaris 4 pin To MP3-RZ# H4/9003 Connection Diagram

The H4/9003 Connector shown refers to the adaptors that are included with the MP3-RZxxx Lights.  
 This diagram **DOES NOT** reference the connector attached to the MP3-RZxxx Light assembly.  
 This diagram illustrates how to correctly assemble the mating harness which will then connect to the headlight assemblies

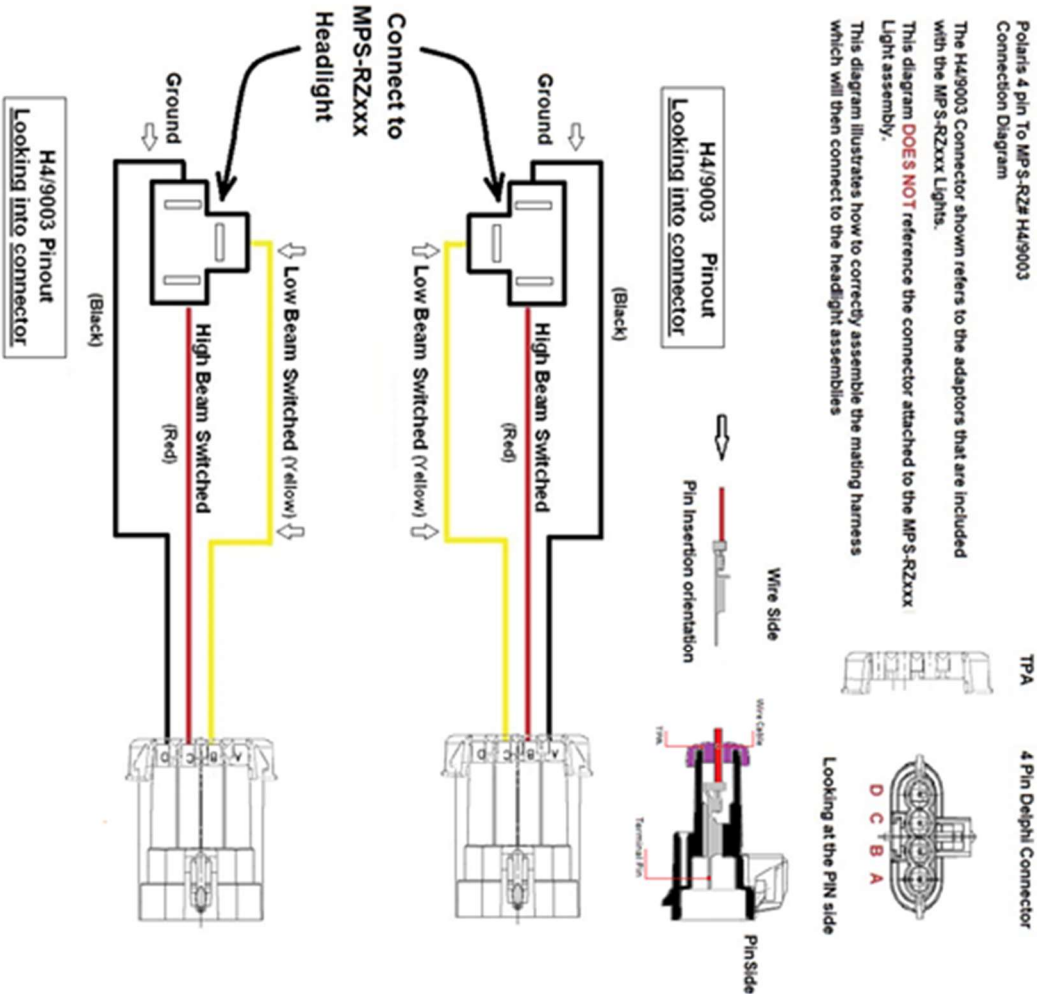

TPA

4 Pin Delphi Connector



Looking at the PIN side

Wire Side

Pin Insertion orientation

Pin Side

- STEP 1:** PLUG LEADS TO CONNECTOR ASSEMBLY PER PRINT.
- STEP 2:** AFTER ALL LEADS ARE PLUGGED, ATTACH THE TPA TO CONNECTOR.
- A. HOLD CONNECTOR WITH PLUGGING SIDE AWAY FROM HAND. HOLD TPA WITH FLAT SIDE TOWARD PALM.
  - B. LINE UP NIBS WITH CORRESPONDING GROOVES, AND VERIFY ONE LEAD PER CAVITY, APPLY PRESSURE WITH FINGERS UNTIL TPA SNAPS INTO PLACE.

**Polaris OEM Headlight 4 Pin Connector**

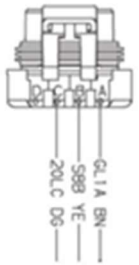

PIN	FUNCTION
A	GROUND
B	HIGH BEAM
C	LOW BEAM
D	NONE

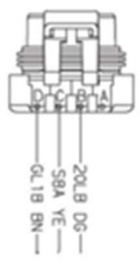

PIN	FUNCTION
A	NONE
B	LOW BEAM
C	HIGH BEAM
D	GROUND



Vehicles equipped with 3 pin plug, or H13 Halogen Bulb style headlamps Refer to Diagram #2

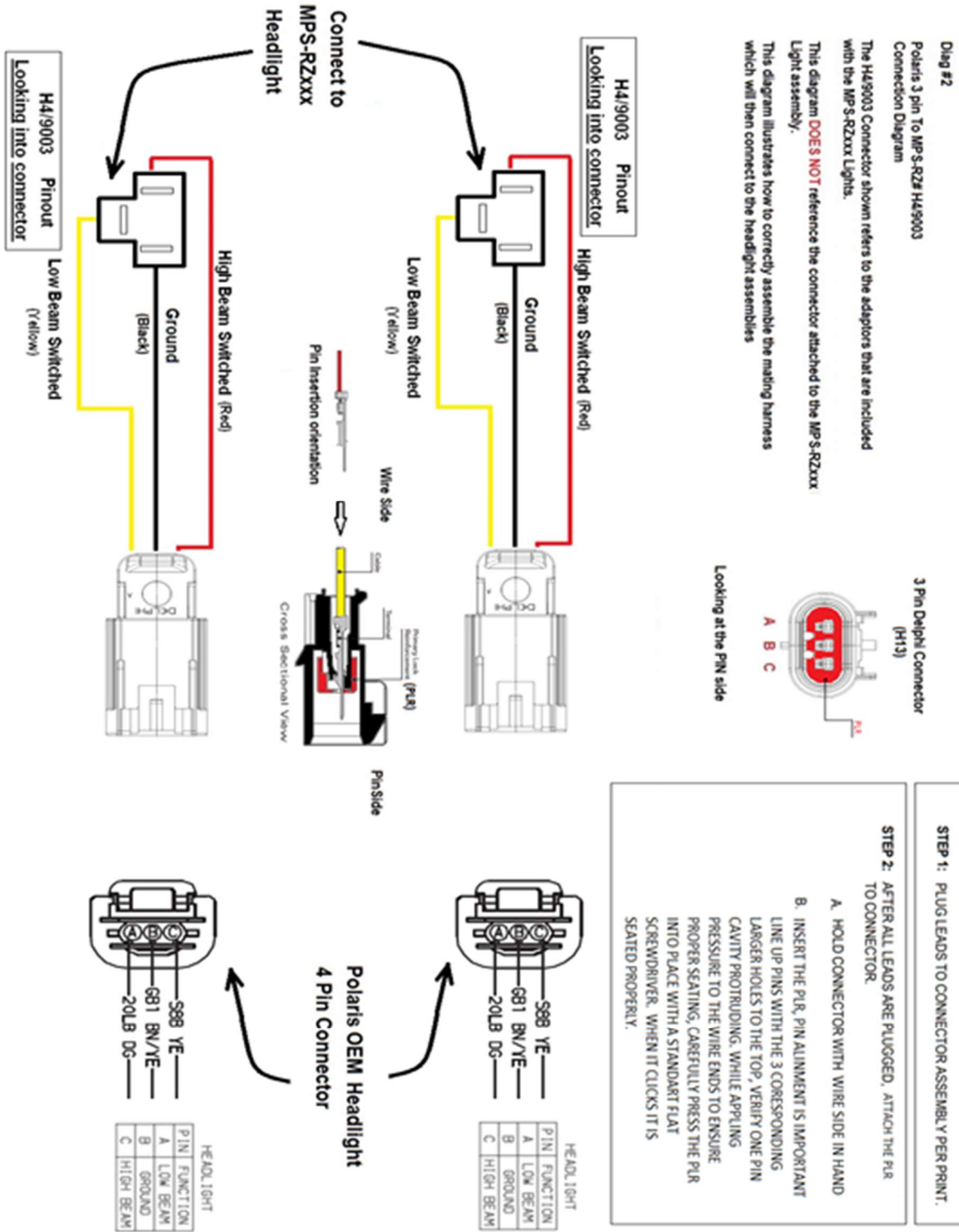





Aiming your Lights:

4. Aim your low beam lights slightly lower than your line of sight so that you have good coverage right in front of the vehicle and far enough in the distance to see without hindering oncoming traffic.

## MAINTENANCE

### Lights

#### Headlight High Beam Adjustment

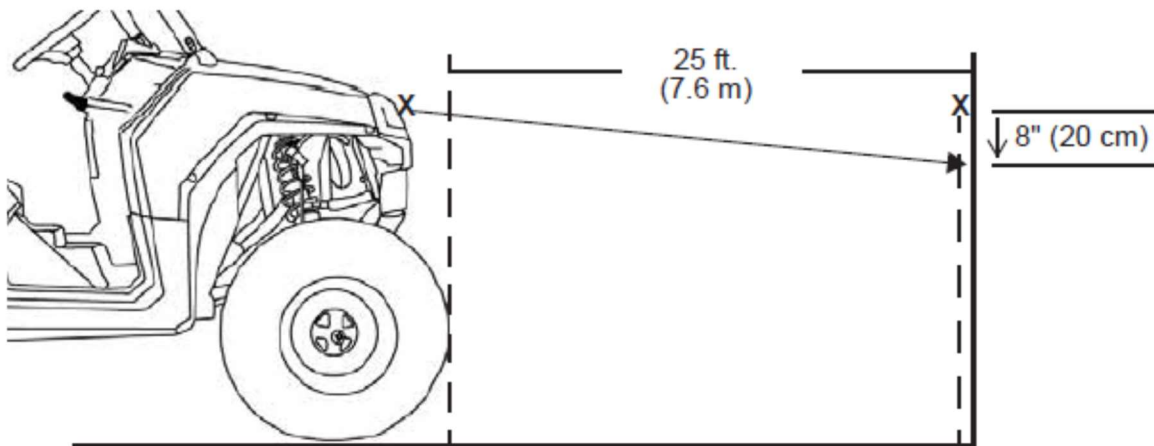

1. Place the vehicle on a level surface with the headlight approximately 25 ft. (7.6 m) from a wall. Place the transmission in PARK.
2. Measure the distance from the floor to the center of the headlight and make a mark on the wall at the same height.
3. Apply the brakes. Start the engine. Turn the headlights to high beam.
4. Observe the headlight aim. The most intense part of the headlight beam should be aimed 8" (20 cm) below the mark placed on the wall in step 2. Include the weight of a rider on the seat while performing this step.
5. If adjustment is necessary, turn the headlight adjustment screw to adjust the beam.
6. Repeat steps 4-5 until the beam is properly adjusted.



Wiring connection Reference

Diagram

### MPS-RZ1RGB Headlight Wiring Connection Reference

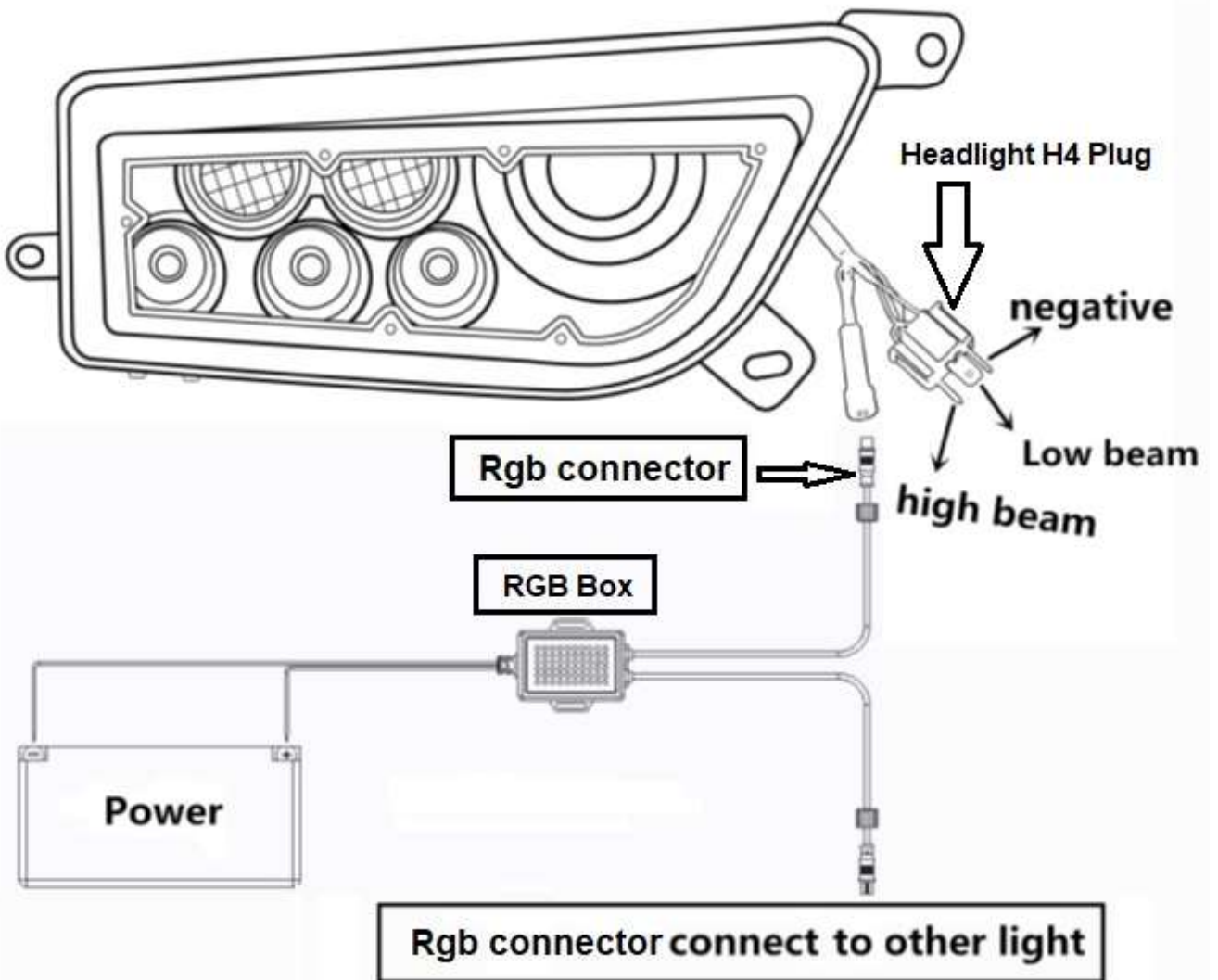



## MPS-RZ1LEDH Headlight Wiring Connection Reference

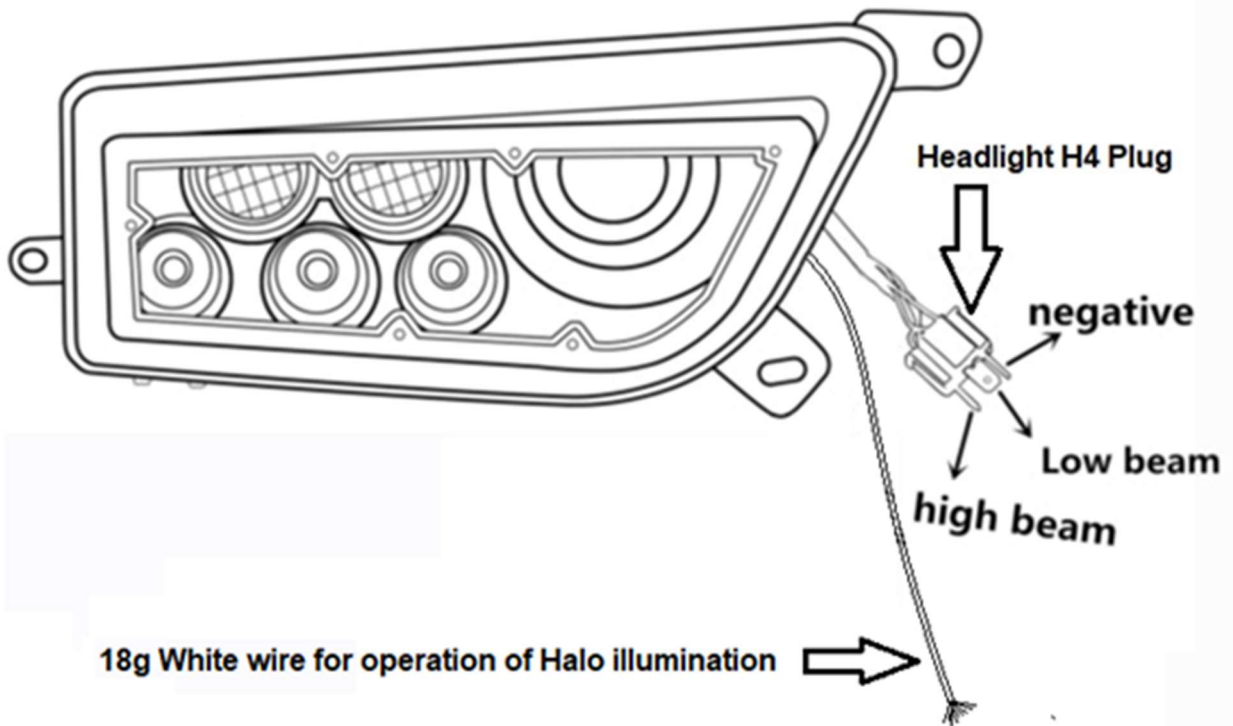

Connect to any +12 volt power supply, switched, Ignition, etc. in order to activate the HALO ring.





App



**CAR LIGHT**





A series of horizontal lines for writing, consisting of 25 evenly spaced lines that span the width of the page.



**1-800-221-0932**  
**[www.MetraPowerSports.com](http://www.MetraPowerSports.com)**  
**460 Walker Street, Holly Hill, FL 32117**

8/16/18